



FAIRWAY 48V TRACK SYSTEM



2021

INHOUDSTAFEL

RAILS

- TRIMLESS.....	3
- SURFACE.....	4
- MINI.....	5

ACCESSOIRES

- Connector	
- Live-End Connector.....	6
- Central Connector.....	6
- Corner 90° Connector.....	6
- End Caps	
- End Caps	6
- End Caps + hole.....	6
- Mini End Caps.....	6
- Mini End Caps + hole.....	6
- Corners + Straight joiner	
- L-90°hoek (Trim, Sur, Mini).....	6
- Straight Joiner.....	6

DRIVERS

- LED Drivers	7
---------------------	---

SPOTS

- Tube 10W.....	8
- Tube 18W	9
- Tube 2x10W.....	10
- Linear lens.....	11
- Linear opal.....	12

INHOUDSTAFEL

Table des matières



TRIMLESS

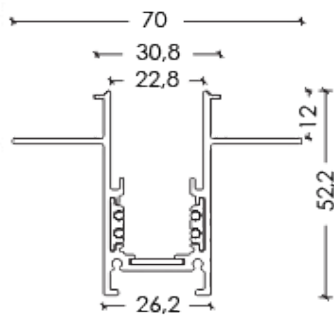

Afmetingen in mm
Dimensions en mm

Productcode	Lengte	Brutoprijs
Code produit	Longueur	Prix bruto
L25.48VTT	2m	€ 160,00



SURFACE

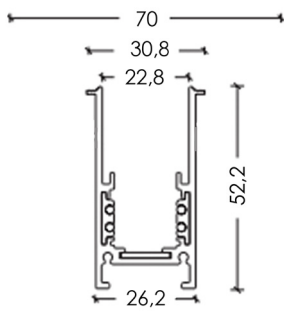

Afmetingen in mm
Dimensions en mm

Productcode	Lengte	Brutoprijs
Code produit	Longueur	Prix bruto
L25.48VTS	2m	€ 140,00



MINI

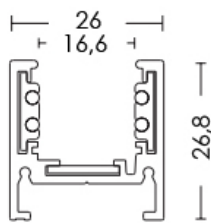

Afmetingen in mm
Dimensions en mm

Productcode	Lengte	Brutoprijs
Code produit	Longueur	Prix brut
L25.48VTSMINI	2m	€ 160,00



ACCESSOIRES

Connector

Productcode	Naam	Lengte	Brutoprijs
Code produit	Nom	Longeur	Prix bruto
L25.48VENDCON	Live-End connector	112 mm	€ 10,00
L25.48VCENCON	Central connector	105 mm	€ 12,00
L25.48VLEXCON	Corner 90° connector	112 mm	€ 25,00

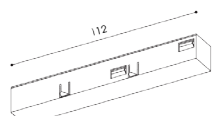

I Live-End connector

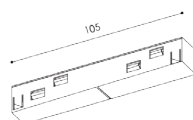

I Central connector

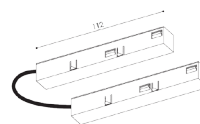

I Corner 90° connector

End caps

Productcode	Naam	Kleur	Geschikt voor	Brutoprijs
Code produit	Nom	Couleur	Convient à	Prix bruto
L25.48VEC	End Cap	Zwart/ Noir	Trimless, Surface, Suspension 48V	€ 1,00
L25.48VEC+H	End Cap + hole	Zwart/ Noir	Trimless, Surface, Suspension 48V	€ 1,00
L25.48VMC	Mini End Cap	Zwart/ Noir	Surface short, Suspension short 48V	€ 1,00
L25.48VMC+H	Mini End Cap + hole	Zwart/ Noir	Surface short, Suspension short 48V	€ 1,00



I End Cap



I End Cap + hole

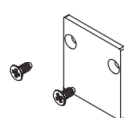

I Mini End Cap

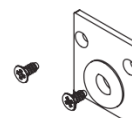

I Mini End Cap + hole

Corners + Straight Joiner

Productcode	Naam	Geschikt voor	Brutoprijs
Code produit	Nom	Convient à	Prix bruto
L25.48V-L-CORN TRIM	L-90°hoek	Trimless	€ 20,00
L25.48V-L-CORN SUR	L-90°hoek	Surface	€ 20,00
L25.48V-L-CORN MINI	L-90°hoek	Mini	€ 20,00
L25.48VSTRAIGHTJOIN	Trimless, Surface, Mini		€ 3,00

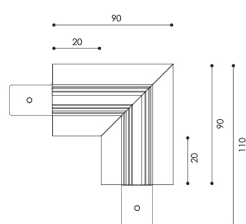

I L-90°hoek (trimless)

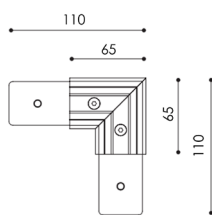

I L-90°hoek (surface)

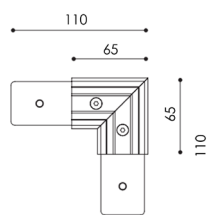

I L-90°hoek (mini)

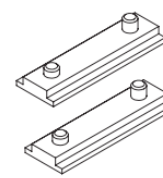

I Straight Joiner



LED DRIVER

LED-driver

Productcode	Omschrijving	Wattage	Afmetingen (LxBxH)	PF	Brutoprijs
Code produit	Description	Puissance	Dimensions	PF	Prix bruto
ELG-75-48	Voeding 48VDC 75W IP67 incl. 30cm kabel	74 W	180 x 63 x 35	0,95	€ 63,00
ELG-100-48	Voeding 48VDC 100W IP67 incl. 30cm kabel	100 W	199 x 63 x 35	0,95	€ 73,00
ELG-150-48	Voeding 48VDC 150W IP67 incl. 30cm kabel	150 W	219 x 63 x 35	0,95	€ 80,00
ELG-200-48	Voeding 48VDC 200W IP67 incl. 30cm kabel	200 W	244 x 71 x 37	0,95	€ 131,00



ELG-200-48



TUBE 10W

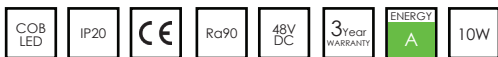

Article code	Dimensions	IP	Colour	Input	Angle	Lumin	CRI	Temperature	Dimmable	Price
L25.48V TUBE 10W	Ø55x120 mm	IP20	3000 K	DC 48V	24°	> 800lm	> 90Ra	-20°C ~ +50°C	DALI 2	160,00

- * The lamps can be easily installed and taken down from the 48V magnetic track.
- * The lamps can be tiltable from 0 to 90°.
- * High quality extrusion aluminum materials, Black and white are standard.
- * Selection of dimming drivers including 1-10V and DALI dimmable.
- * Single and double options, meet the dynamic lighting environment to any directions.



TUBE 18W

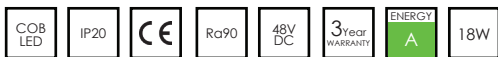

Article code	Dimensions	IP	Colour	Input	Angle	Lumin	CRI	Temperature	Dimmable	Price
L25.48V TUBE 18W	Ø55x170 mm	IP20	3000 K	DC 48V	24°	> 1400lm	> 90Ra	-20°C ~ +50°C	DALI 2	168,00

- * The lamps can be easily installed and taken down from the 48V magnetic track.
- * The lamps can be tiltable from 0 to 90°.
- * High quality extrusion aluminum materials, Black and white are standard.
- * Selection of dimming drivers including 1-10V and DALI dimmable.
- * Single and double options, meet the dynamic lighting environment to any directions.



TUBE 2x10W

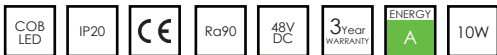

Article code	Dimensions	IP	Colour	Input	Angle	Lumin	CRI	Temperature	Dimmable	Price
L25.48V TUBE 2x10	Ø55x120 mm	IP20	3000 K	DC 48V	24°	> 1600lm	> 90Ra	-20°C ~ +50°C	DALI 2	200,00

- * The lamps can be easily installed and taken down from the 48V magnetic track.
- * The lamps can be tiltable from 0 to 90°.
- * High quality extrusion aluminum materials, Black and white are standard.
- * Selection of dimming drivers including 1-10V and DALI dimmable.
- * Single and double options, meet the dynamic lighting environment to any directions.



LINEAR LENS



Article code	Dimensions	IP	Colour	Input	Angle	Lumin	CRI	Temperature	Dimmable	Price
L25.48V LINEAR LENS	244x22x44mm	IP20	3000 K	DC 48V	120°	> 800lm	> 80Ra	-20°C ~ +50°C	DALI 2	136,00

- * The lamps can be easily installed and taken down from the 48V magnetic track.
- * High quality extrusion aluminum materials, Black and white are standard.
- * Selection of dimming drivers including 1-10V and DALI dimmable.



LINEAR OPAL



Article code	Dimensions	IP	Colour	Input	Angle	Lumin	CRI	Temperature	Dimmable	Price
L25.48V LINEAR OPAL	244x22x44mm	IP20	3000 K	DC 48V	120°	> 800lm	> 80Ra	-20°C ~ +50°C	DALI 2	136,00

- * The lamps can be easily installed and taken down from the 48V magnetic track.
- * High quality extrusion aluminum materials, Black and white are standard.
- * Selection of dimming drivers including 1-10V and DALI dimmable.

